



Uputstvo za upotrebu

LED reflektor

4058075420908 **FL PFM 10W/4000K SYM 100 WT LEDV**, 4058075420946 **FL PFM 10W/6500K SYM 100 WT LEDV**,
4058075421073 **FL PFM 20W/6500K SYM 100 WT LEDV**, 4058075421202 **FL PFM 30W/6500K SYM 100 WT LEDV**,
4058075421325 **FL PFM 50W/6500K SYM 100 WT LEDV**, 4058075421035 **FL PFM 20W/4000K SYM 100 WT LEDV**,
4058075421288 **FL PFM 50W/4000K SYM 100 WT LEDV**, 4058075421165 **FL PFM 30W/4000K SYM 100 WT LEDV**

Pre prve upotrebe detaljno proučite ovo uputstvo i sačuvajte ga.

PUŠTANJE U RAD

Paznja! Montažu i puštanje u rad sme da vrši samo stručno lice uz pridržavanje aktuelnih propisa bezbednosti!

1. Paznja! Pre montaže i povezivanja reflektora, isključivanjem osigurača isključite struju!
2. Reflektor nije pogodan za redno povezivanje!
3. Reflektor se sme montirati samo na unapred montirane kablove u objektu!
4. Pre montaže proverite da li imate na raspolaganju sve što je potrebno za montažu i povezivanje!
5. Pomoću tipli i šarafa (nisu u sklopu) montirajte reflektor na površinu dovoljne nosivosti, minimalna visina za montažu treba da je 1.8 m, a maksimalna 5 m od poda.
6. Sa proizvodom se ne isporučuje redna stezaljka. Za povezivanje koristite standardizovane redne stezaljke (prema EN 60998-2-2).
7. Slobodne krajeve kabela koji su na reflektoru povežite na strujno kolo pomoću vodoootporne strujne razvodne kutije (nije u sklopu). PAŽNJA! Samo se ovako može postići IP65 zaštita!
8. Kablove povežite prema sledećoj tabeli.
9. Samo nakon stručne montaže i stručnog povezivanja sme da se uključi napajanje.

Kablovi stetiljke	Kablovi instalacije
L, braon ili crni provodnik	Faza (L): braon ili crni provodnik
N, plavi provodnik	Nula (N): plavi provodnik
 žuto-zeleni provodnik	Uzemljenje: žuto-zeleni provodnik

OTKLANJANJE GREŠKE

Greška	Moguće rešenje
Reflektor ne svetli.	Proverite povezivanja i napajanje.

NAPOMENE

1. Uverite se da proizvod nije oštećen prilikom transporta!
2. Montažu i puštanje u rad sme da vrši samo stručno lice uz pridržavanje aktuelnih propisa bezbednosti!
3. Pomoću tipli i šarafa montirajte reflektor na površinu dovoljne nosivosti, minimalna visina za montažu treba da je 1.8 m, a maksimalna 5 m od poda.
4. Za povezivanje koristite standardizovane redne stezaljke (prema EN 60998-2-2).
5. Reflektor se sme koristiti samo sa zaštitnim staklom!
6. Izvor svetlosti u lampi nije zamenljiv. Nakon isteka radnog veka čitava lampa se smatra elektronskim otpadom.
7. Lampa nije pogodna za redno povezivanje.
8. Iz razloga konstantnog razvoja i poboljšavanja kvaliteta promene u karakteristikama i dizajnu mogu se desiti i bez najave.
9. Aktuelno uputstvo za upotrebu možete pronaći na adresi www.elementa.rs.
10. Za eventualne štamparske greške ne odgovaramo i unapred se izvinjavamo.

ČIŠĆENJE I ODRŽAVANJE

Radi optimalnog rada lampu treba čistiti prema potrebi, minimalno jednom mesečno.

1. Pre čišćenja isključite lampu!
2. Ostavite je da se ohladi (minimum 30 min.).
3. Blago nakvašenom krpom prebrišite spoljni deo lampe. Ne koristite agresivna hemijska sredstva! Voda ne sme da uciri u lampu i na električne komponente!

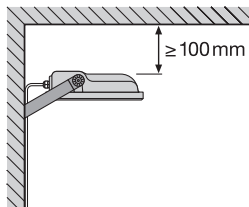

Reflektor koji je usmeren prema dole, treba da je montiran od plafona (opšiva, oluka) najmanje 10 cm!

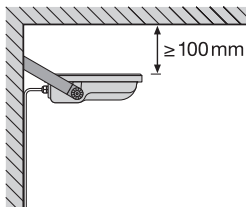

Minimalna razdaljina između reflektora i osvetljene površine!

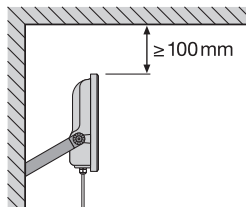

U slučaju uspravno podešenog reflektora razdaljina od gore treba da je najmanje 10 cm, a sa zadnje strane 5 cm radi odgovarajućeg hlađenja!

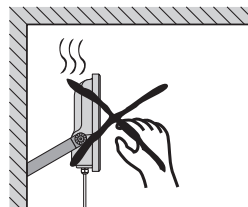

U toku i nakon rada ne pijajte reflektor.

TEHNIČKI PODACI

Model:	4058075420908	4058075420946	4058075421073	4058075421288
	FL PFM 10W/4000K SYM 100 WT LEDV	FL PFM 10W/6500K SYM 100 WT LEDV	FL PFM 20W/6500K SYM 100 WT LEDV	FL PFM 50W/4000K SYM 100 WT LEDV
Napajanje:	100-277V~	100-277V~	100-277V~	100-277V~
Snaga:	10W	10W	20W	50W
Struja:	49mA	49mA	98mA	236mA
Temperatura svetlosti:	4000K	6500K	6500K	4000K
Jačina svetlosti:	1200lm	1200lm	2400lm	6000lm
Tip LED dioda:	SMD	SMD	SMD	SMD
Ugao svetlosnog zraka:	100°	100°	100°	100°
Faktor snage:	> 0.90	> 0.90	> 0.90	> 0.90
Potrošnja električne energije:	10kWh/1000h	10kWh/1000h	20kWh/1000h	50kWh/1000h
CRI faktor:	≥80	≥80	≥80	≥80
Vreme zagrevanja:	< 0.5s	< 0.5s	< 0.5s	< 0.5s
Radni vek:	70000h	70000h	70000h	70000h
Broj uklj./isklj.:	100000	100000	100000	100000
Značenje IP65:	Zaštićen od prodora prašine. Zaštićen od prskajuće vode (iz svih pravaca).			
Dimabilnost:	NE	NE	NE	NE
Materijal kućišta:	Metal	Metal	Metal	Metal
Masa:	0.4kg	0.4kg	0.52kg	1.0kg
Radna temperatura:	-30C°...+50C°	-30C°...+50C°	-30C°...+50C°	-30C°...+50C°
Dimenzije DxVxŠ:	122x131x36mm	122x131x36mm	144x156x42mm	206x218x46mm
Izolaciona klasa:	klasa I	klasa I	klasa I	klasa I
Model:	4058075421202	4058075421325	4058075421035	4058075421165
	FL PFM 30W/6500K SYM 100 WT LEDV	FL PFM 50W/6500K SYM 100 WT LEDV	FL PFM 20W/4000K SYM 100 WT LEDV	FL PFM 30W/4000K SYM 100 WT LEDV
Napajanje:	100-277V~	100-277V~	100-277V~	100-277V~
Snaga:	30W	50W	20W	30W
Struja:	147mA	236mA	98mA	147mA
Temperatura svetlosti:	6500K	6500K	4000K	4000K
Jačina svetlosti:	3600lm	6000lm	2400lm	3600lm
Tip LED dioda:	SMD	SMD	SMD	SMD
Ugao svetlosnog zraka:	100°	100°	100°	100°
Faktor snage:	> 0.90	> 0.90	> 0.90	> 0.90
Potrošnja električne energije:	30kWh/1000h	50kWh/1000h	20kWh/1000h	30kWh/1000h
CRI faktor:	≥80	≥80	≥80	≥80
Vreme zagrevanja:	< 0.5s	< 0.5s	< 0.5s	< 0.5s
Radni vek:	70000h	70000h	70000h	70000h
Broj uklj./isklj.:	100000	100000	100000	100000
Značenje IP65:	Zaštićen od prodora prašine. Zaštićen od prskajuće vode (iz svih pravaca).			
Dimabilnost:	NE	NE	NE	NE
Materijal kućišta:	Metal	Metal	Metal	Metal
Masa:	0.7kg	1.0kg	0.52kg	0.7kg
Radna temperatura:	-30C°...+50C°	-30C°...+50C°	-30C°...+50C°	-30C°...+50C°
Dimenzije DxVxŠ:	177x186x42mm	206x218x46mm	144x156x42mm	177x186x42mm
Izolaciona klasa:	klasa I	klasa I	klasa I	klasa I



Najbliži predmet u snopu svetlosti reflektora! (ne sme biti manje od 1,0 m)



Oštećeni priključni kabel nije zamenjiv. Ako se desi oštećenje, proizvod više nije za upotrebu.



Opasnost od strujnog udara! Zabranjeno rastavljati uređaj i njegove delove prepravljati! U slučaju bilo kojeg kvara ili oštećenja, odmah isključite uređaj i obratite se stručnom licu!



Slomljeno staklo treba zameniti!



Nakon isteka radnog veka ovog proizvoda, proizvod ne bacajte sa otpadom iz domaćinstva. Elektronski otpad se predaje u reciklažne centre tog tipa. Ovim postupkom štite okolinu, vaše zdravlje i zdravlje ostalih. U reciklažnim centrima se informišite u prodavnici gde ste ovaj proizvod kupili.



Ne gledajte u LED izvor svetlosti.

Oznaka: 4058075420908 **FL PFM 10W/4000K SYM 100 WT LEDV**, 4058075420946 **FL PFM 10W/6500K SYM 100 WT LEDV**, 4058075421073 **FL PFM 20W/6500K SYM 100 WT LEDV**, 4058075421202 **FL PFM 30W/6500K SYM 100 WT LEDV**, 4058075421325 **FL PFM 50W/6500K SYM 100 WT LEDV**, 4058075421035 **FL PFM 20W/4000K SYM 100 WT LEDV**, 4058075421288 **FL PFM 50W/4000K SYM 100 WT LEDV**, 4058075421165 **FL PFM 30W/4000K SYM 100 WT LEDV**
 Proizvođač: LEDVANCE Lighting Co, Ltd;

Zemlja porekla: Kina

Uvoznik za Srbiju: Reflekta Doo; Srbija, Novi Sad, Rumenačka 23

PRODUCT DATASHEET

FL PFM 20 W 4000 K SYM 100 WT

FLOODLIGHT 20 W | Versatile floodlight with up to 2400 lm light output



Areas of application

- Replacement for floodlights with halogen lamps
- Outdoor use (IP65)
- Public areas
- Building facades
- Construction areas
- Gardens, balconies and other outdoor areas

Product benefits

- Bright, robust and durable
- Safe and very uniform illumination, due to frosted and tempered glass diffuser
- No upper light output ratio (ULOR 0%) when mounted at 0° tilt
- Energy savings of up to 90 % compared to halogen lamp floodlights
- 5 years guarantee

Product features

- Reflector-based, symmetric light distribution with 100° x 100° beam angle
- Integrated wide voltage driver, suitable for 100 - 277 V AC
- Surge protection: up to 4 kV (L/N-PE), 2 kV (L-N)
- Mounting bracket with 30° angle and wide rotation area
- Pre-installed, flexible 1 m cable (H05RN-F), wrapped 3 x 1.0 mm² single wires



TECHNICAL DATA

Electrical data

Nominal wattage	20.00 W
Nominal voltage	100...277 V
Mains frequency	50...60 Hz
Nominal current	98 mA
Inrush current	5.68 A
Inrush current time T_{h50}	35 μ s
Max. no. of lum. on circuit break. B16 A	93
Max. no. of lum. on circuit break. C10 A	67
Max. no. of lum. on circuit break. C16 A	108
Power factor λ	> 0.90
Total harmonic distortion	< 20 %
Protection class	I
Operating mode	Integrated LED driver

Photometrical data

Luminous flux	2400 lm
Luminous efficacy	120 lm/W
Color temperature	4000 K
Light color (designation)	Cool White
Color rendering index Ra	≥ 80
Standard deviation of color matching	≤ 5 sdc _m
Luminous intensity	-
Flickering metric (Pst LM)	-
Stroboscope effect metric (SVM)	-
Photobiological safety group acc. to EN62778	RG1
Photobiological safety group acc. to EN62471	RG1
Beam angle	100 ° x 100 °

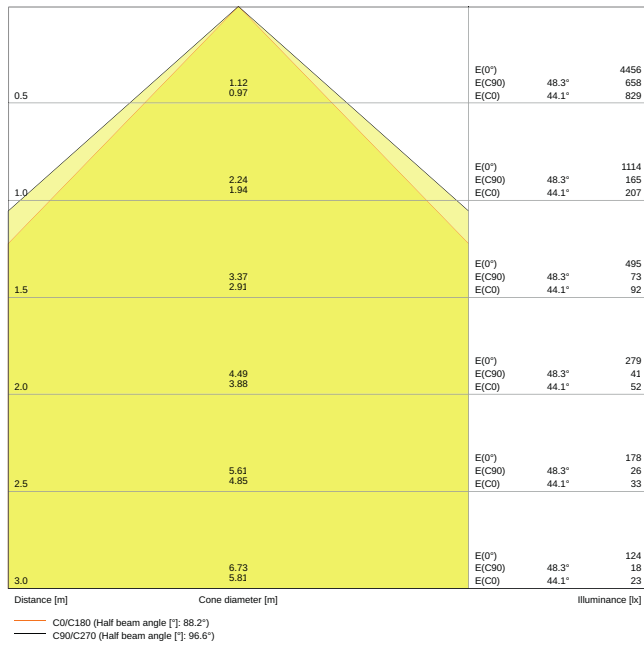

LDC typ cone

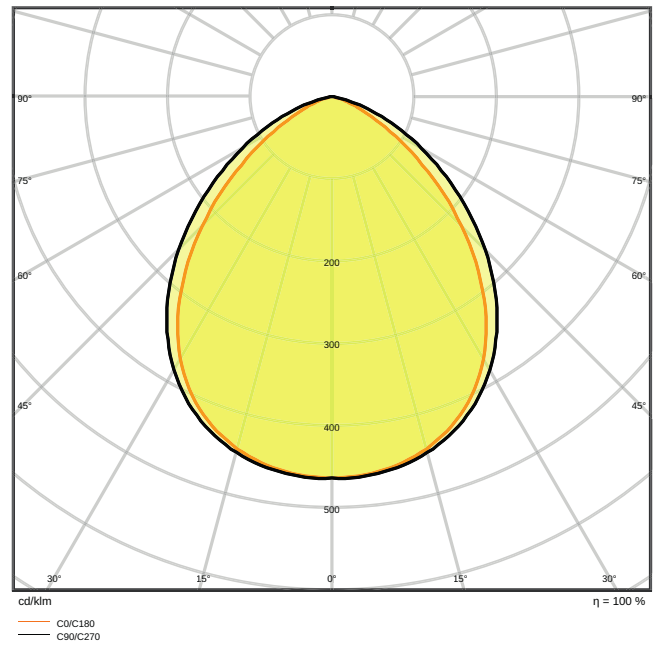

LDC typ polar

Dimensions & Weight

Length	144.00 mm
Width	156.00 mm
Height	42.00 mm
Product weight	520.00 g
Cable length	1000 mm

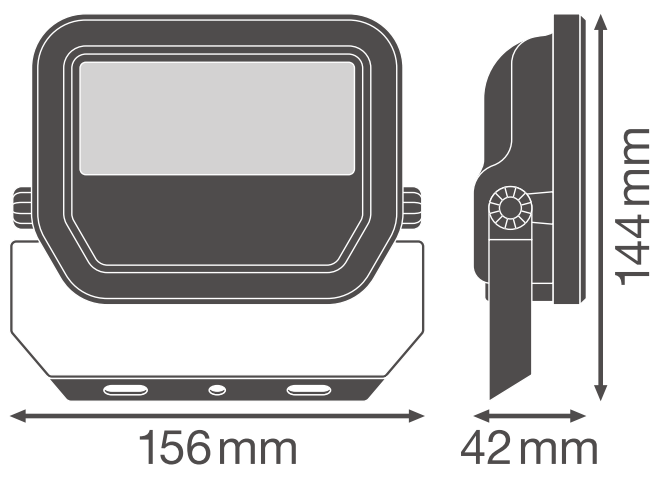

Product line drawing with numbers

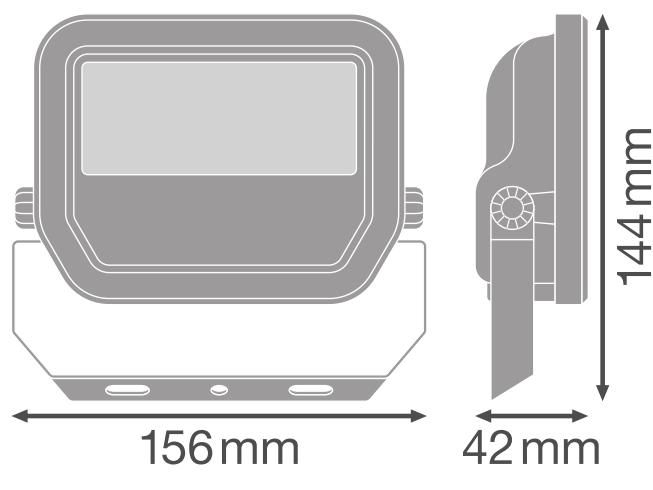

Product line drawing with numbers

Materials & Colors

Product color	White
Housing color	White
Body material	Aluminum
Light emitting surface material	Glass
Glow Wire Test according to IEC 60695-2-12	650 °C
Mercury content	0.0 mg

Application & Mounting

Ambient temperature range	-30...+50 °C
Temperature range at storage	-40...+70 °C
Type of connection	Cable, 3-pole
Type of protection	IP65
Protection class IK (shock resistance)	IK07
Dimmable	No
Mounting type	Surface
Mounting location	Wall / Ceiling / Floor
Adjustable	Yes
LED module replaceable	Not replaceable

Lifespan

Lifespan L70/B50 at 25 °C	70000 h
Lifespan L80/B10 at 25 °C	55000 h
Lifespan L90/B10 at 25 °C	35000 h
Number of switching cycles	100000









Control gear

ECG - Output ripple current	< 50 %
-----------------------------	--------

Certificates & Standards

Standards	CE / CB / ENEC / EAC / RoHS
Luminaire with limited surface temperature, "D sign"	No
Ball shot safe	No

DOWNLOAD DATA

DOWNLOAD DATA	
	User instruction FLOODLIGHT
	Tender documents Tender Text 4058075421035
	Declarations of conformity FL PFM
	IES file (IES) FL PFM 20W4000K SYM 100 WT
	LDT file (Eulumdat) FL PFM 20W4000K SYM 100 WT
	R3D file (Relux 3D Model) FL PFM 20W
	M4D file (3D Model with rotation axis) FL PFM 20W
	UGR file (UGR table) FL PFM 20W4000K SYM 100 WT
	Packaging insert Legal insert

LOGISTICAL DATA

Product code	Packaging unit (Pieces/Unit)	Dimensions (length x width x height)	Gross weight	Volume
4058075421035	Folding box 1	161 mm x 62 mm x 135 mm	572.00 g	1.35 dm ³
4058075421042	Shipping box 12	396 mm x 336 mm x 161 mm	7510.00 g	21.42 dm ³

The mentioned product code describes the smallest quantity unit which can be ordered. One shipping unit can contain one or more single products. When placing an order, for the quantity please enter single or multiples of a shipping unit.

ADDITIONAL CATALOG INFORMATION

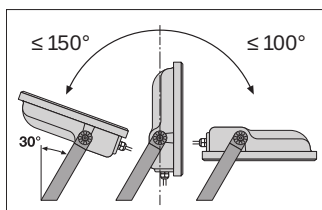

	A	B	C	Weight	Area
10W	38	60	5.5	2x M4	0.014m ²
20W	58	80	8.5	2x M5	0.018m ²
30W	78	90	8.5	2x M5	0.022m ²
50W	78	110	8.5	2x M6	0.028m ²

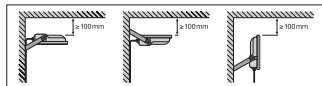
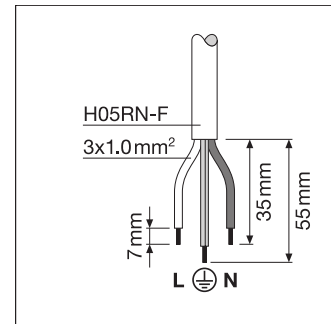

References / Links

- For Guarantee see www.ledvance.com/guarantee

DISCLAIMER

Subject to change without notice. Errors and omission excepted. Always make sure to use the most recent release.